

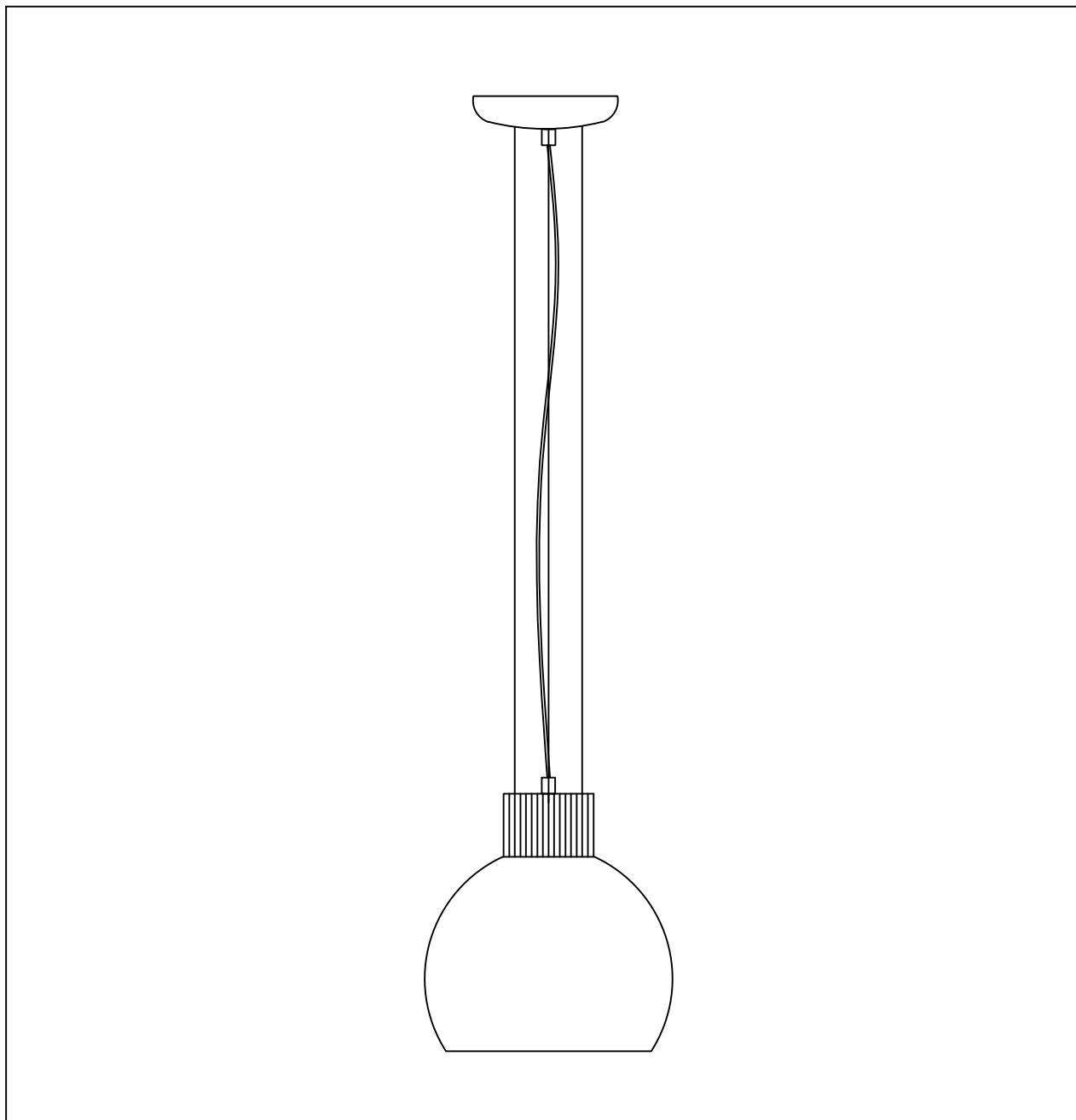

PRODUCT NAME:Hi-Bay 1LT Pendant  
ITEM NUMBER: 25238

Please consult your electrician for hanging fixture and wiring.



Bulbs (Included):1\*LED\*12W

**IMPORTANT:** Turn off the power at the main fuse or circuit breaker box before starting installation



Bracket (A)



Screws(B)

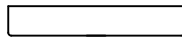

Canopy(C)



Mounting Screws(D)



Plastic  
Screws(E)

Locate all hardware & components before discarding packaging

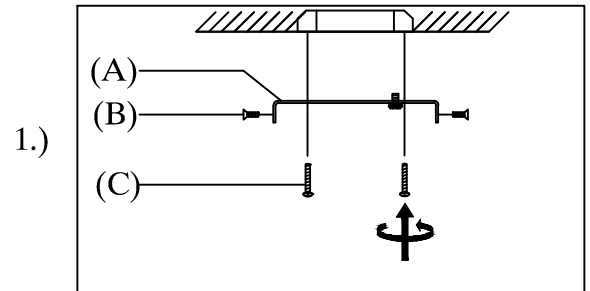
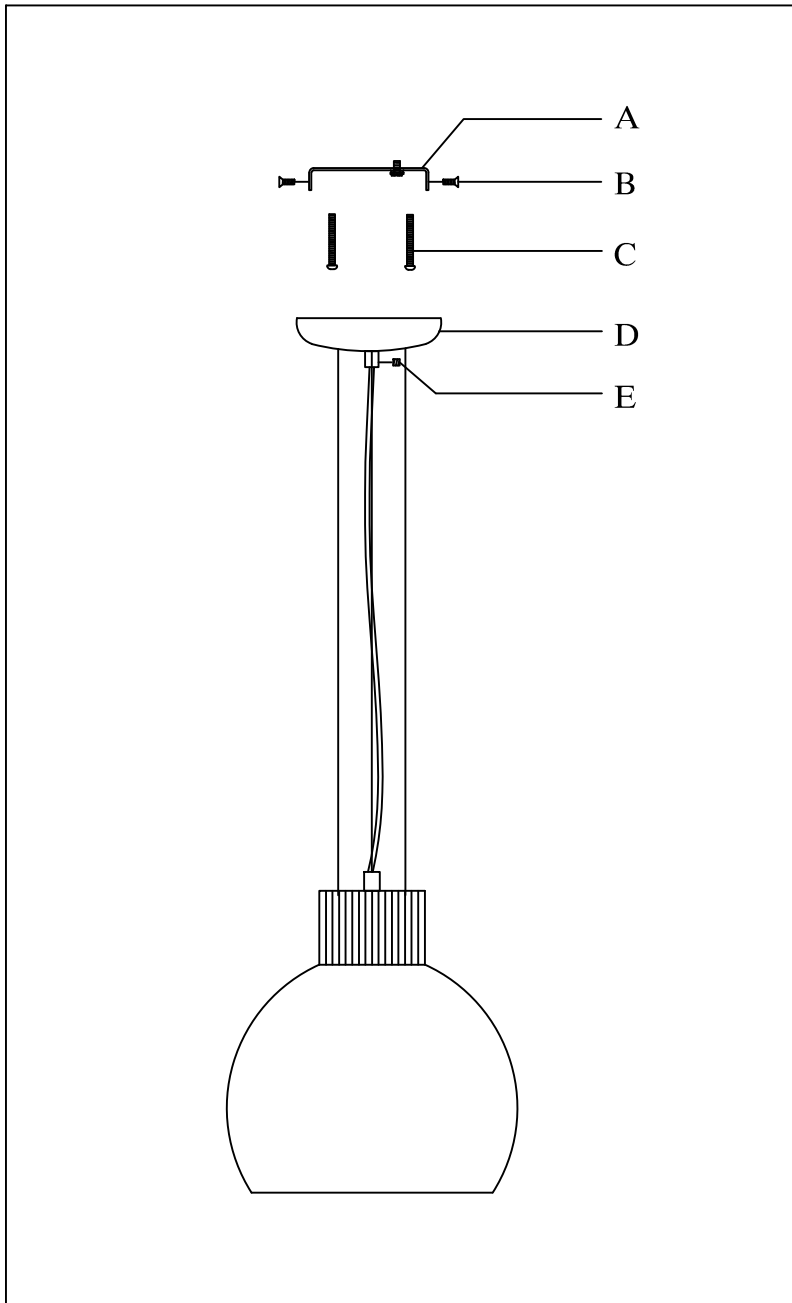

Step1 :Remove mounting bracket from fixture and install to electrical box.

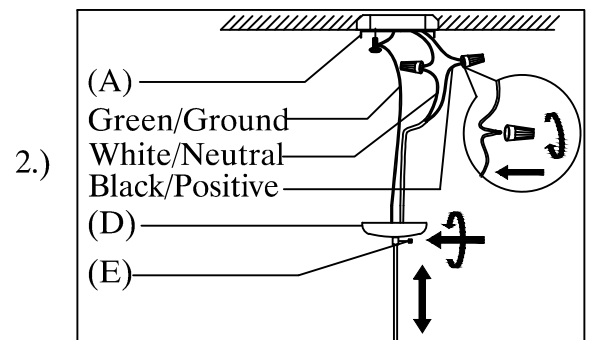

Step2 :Adjust wire length to desired mounting height, and tighten strain relief screws to secure. Wire fixture to wires in outlet box. Green wire is for Ground.

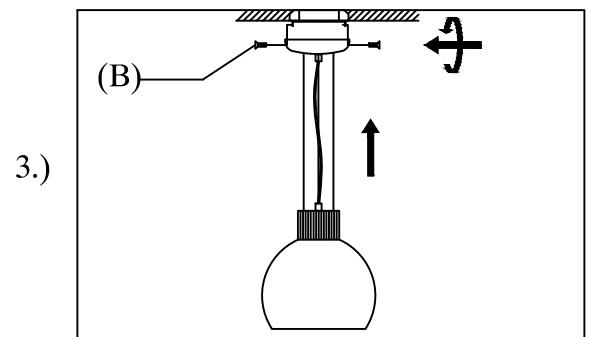

Step3 :Install fixture to bracket and tighten screws at the ends of the canopy to secure. Install bulb into socket.

**Cleaning & Care:**  
Clean with soft cloth and a mild detergent.  
Do not use abrasive cleaner.